

TWIN DRAGON

HIGH PERFORMANCE RACING BOAT

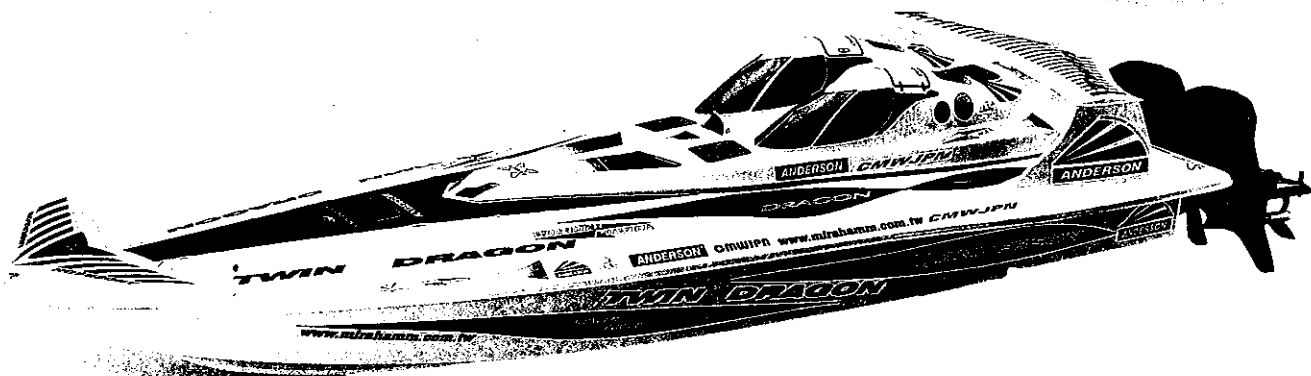

Data Base

Length: 1080mm(Including outboat drive)

Width: 310mm

Height: 250mm

Weight: 3000g

Radio: 2CH&standard servo

Motor: 540/550 motor

Power: 7.2V-8.4V Ni-cd battery pack (1500mAh&up)

ANDERSON®

ANDERSON MODEL CO., LTD

REQUIRED FOR OPERATION

Radio Control Set-2Channel

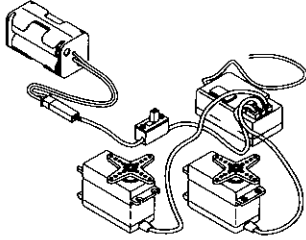

AA-Size Batteries 12Pcs.

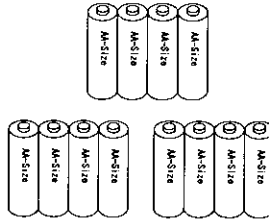

7.2V Ni-Cd Battery & Charger

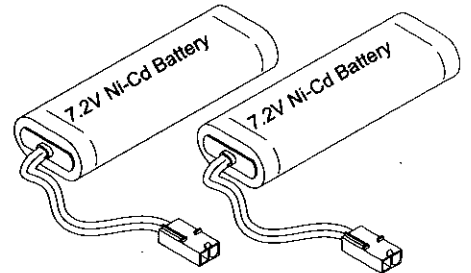

TOOLS REQUIRED

Long Nose Pliers

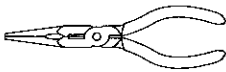

Instant Glue

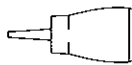

Phillips Screwdriver (L,M,S)



Wire Cutter

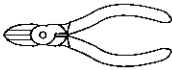

Awl



2mm & 3mm Nut Driver

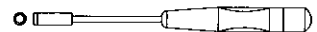

1.5mm 2.0mm Hex Wrench

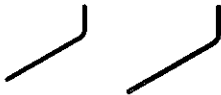

Modeling Knife



Small Scissors



RECOMMENDATIONS IMPORTANTES

1 船台 Boat Stand

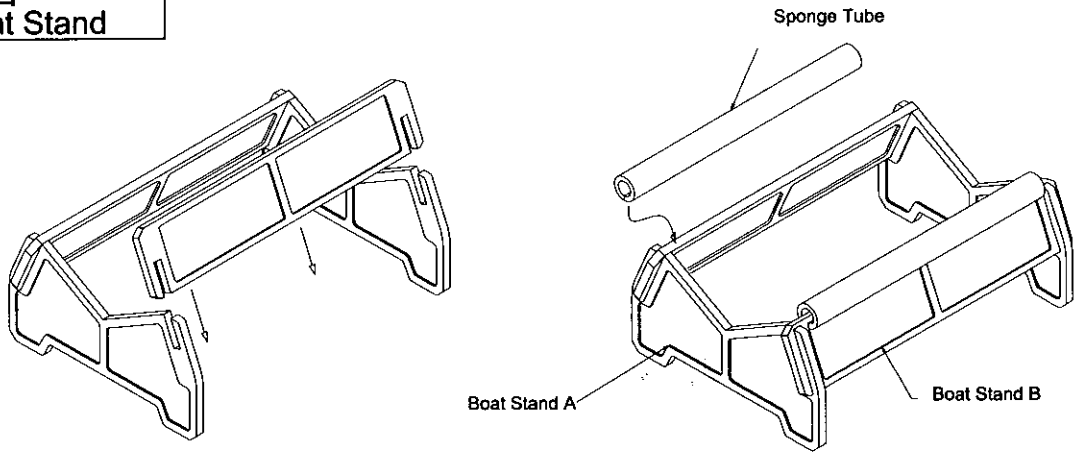

2 接收機盒 Radio Box

- ① 3x10mm Tapping Screw x6
- ② 3x15mm Tapping Screw x2
- ③ 3x20mm Tapping Screw x2
- ④ 2x8mm Tapping Screw x1
- ⑤ x2
- ⑥ 2mm Nut x2

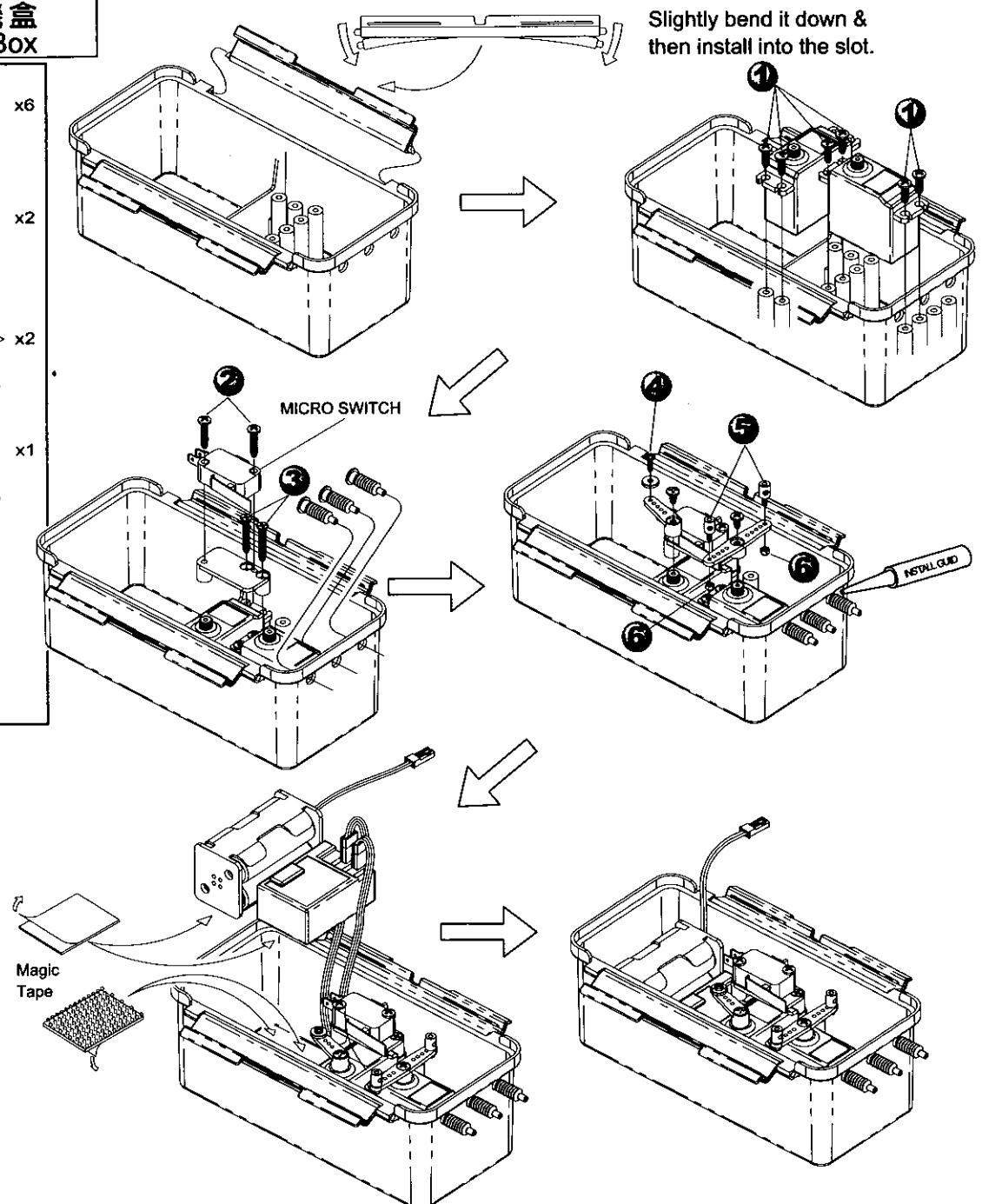

3 船体 Hull

① ■ x2
3x3mm
Set Screw

Double Side Tape

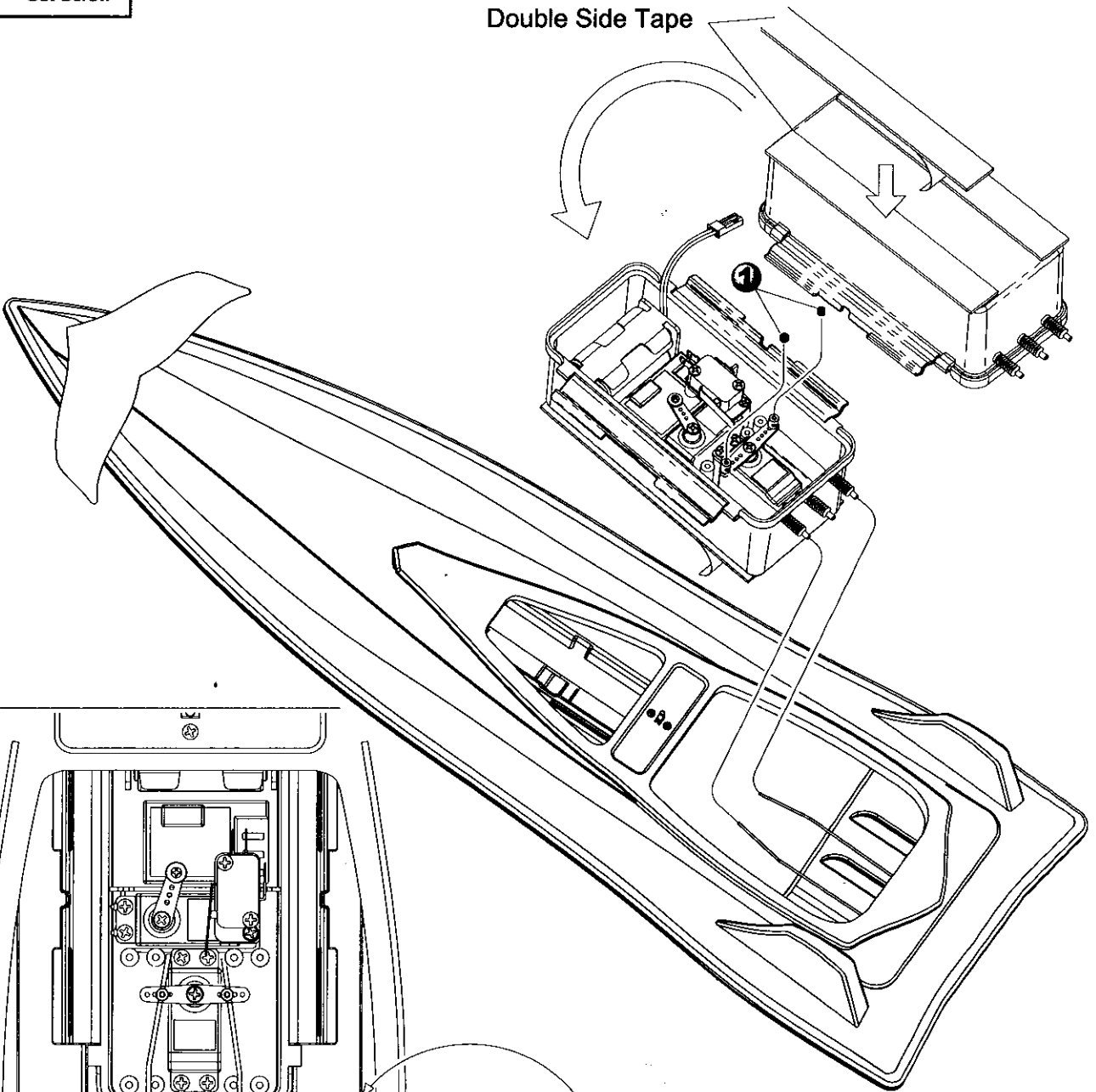

Place the receiver box in the middle
by line up with the marked edeg.

4 接收機盒 Radio Box

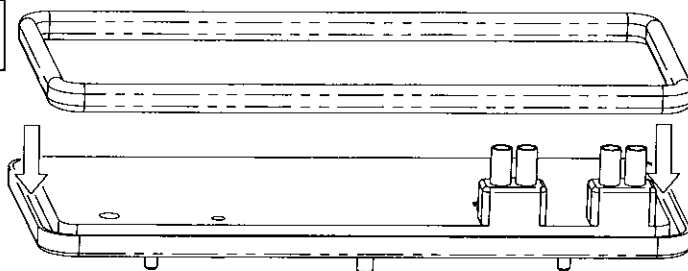

5 船体
Hull

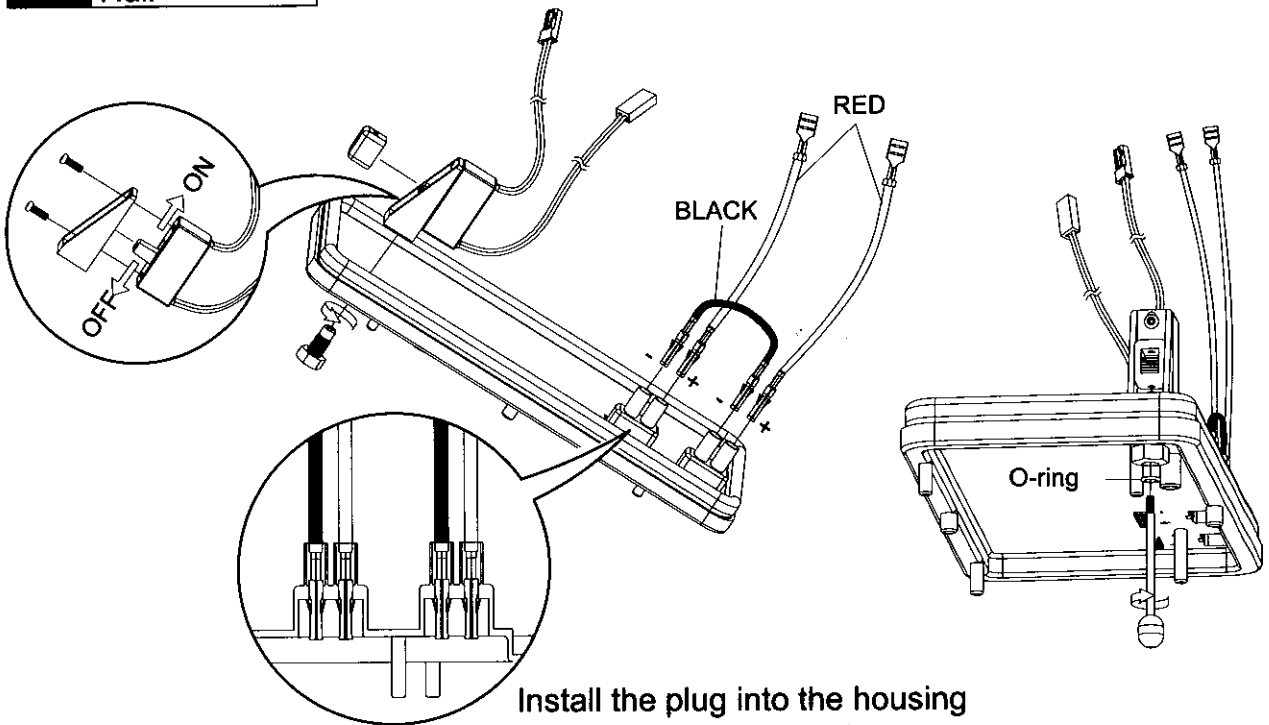

Install the plug into the housing until it is tightly wedged.

6 船体
Hull

When fix the upper cover of the receiver box, be sure not to press down the wiring.

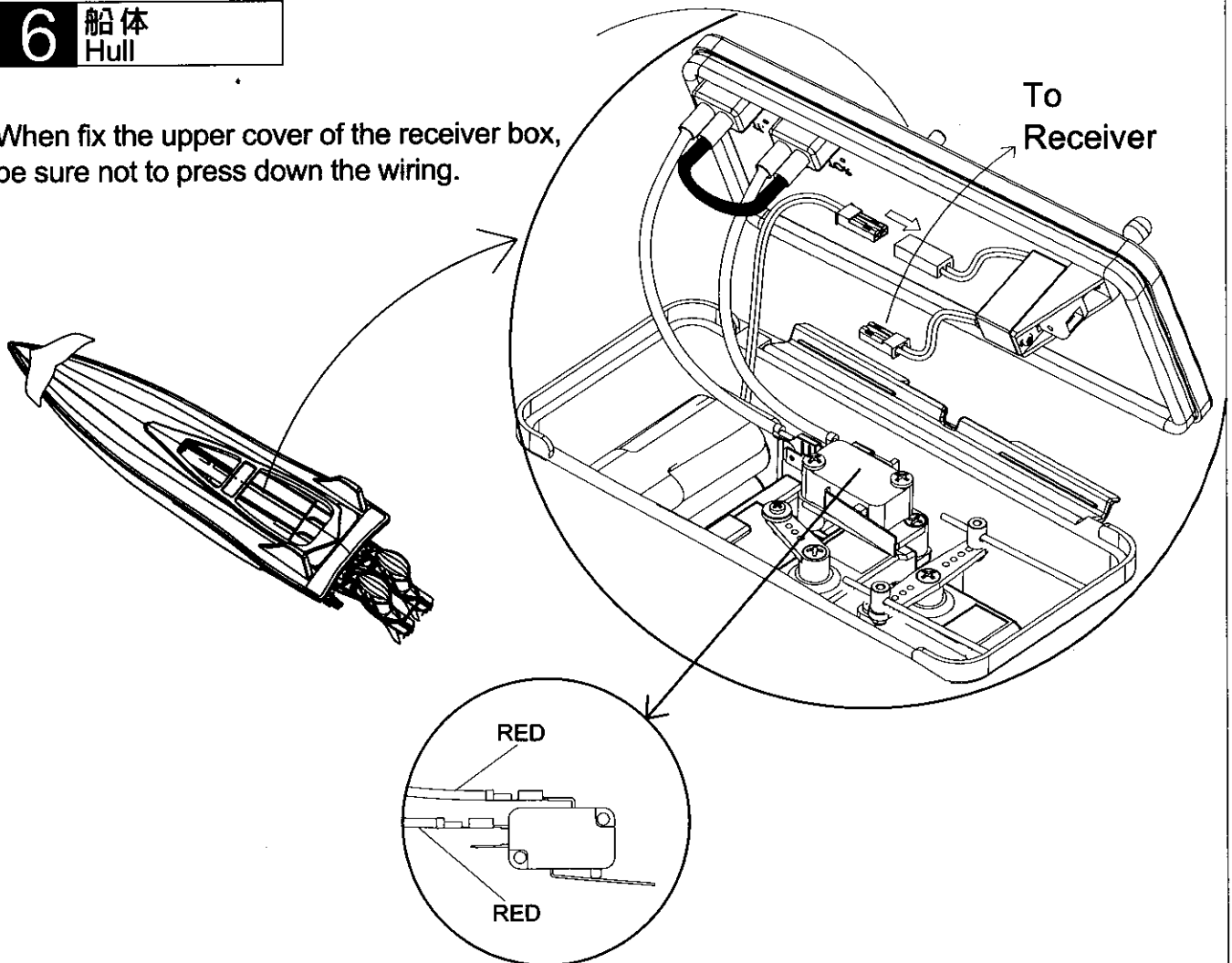

7 船外機 Out board Unit

①  x1
4mm
Nut

②  x1
3x3mm
Set Screw

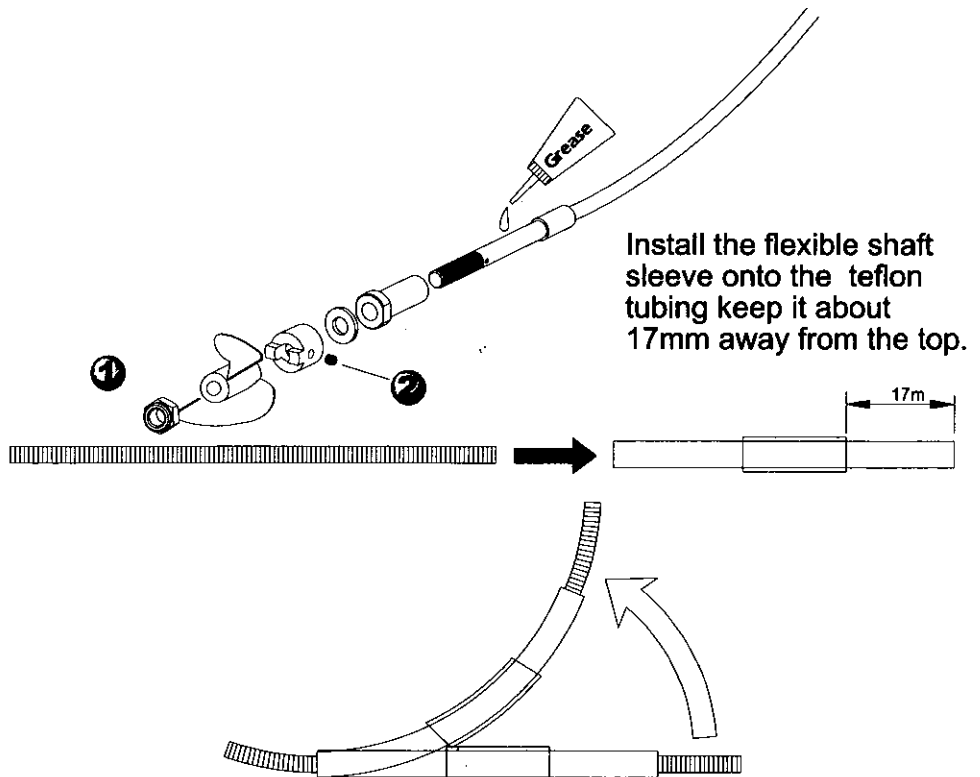

8 船外機 Out board Unit

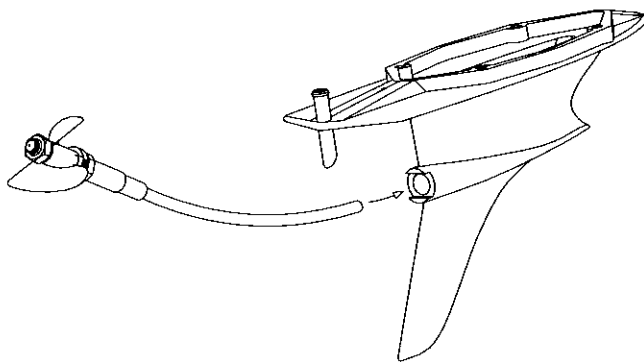

When install the flexible shaft onto the base mount of the out board unit be sure press tightly to the bottom.

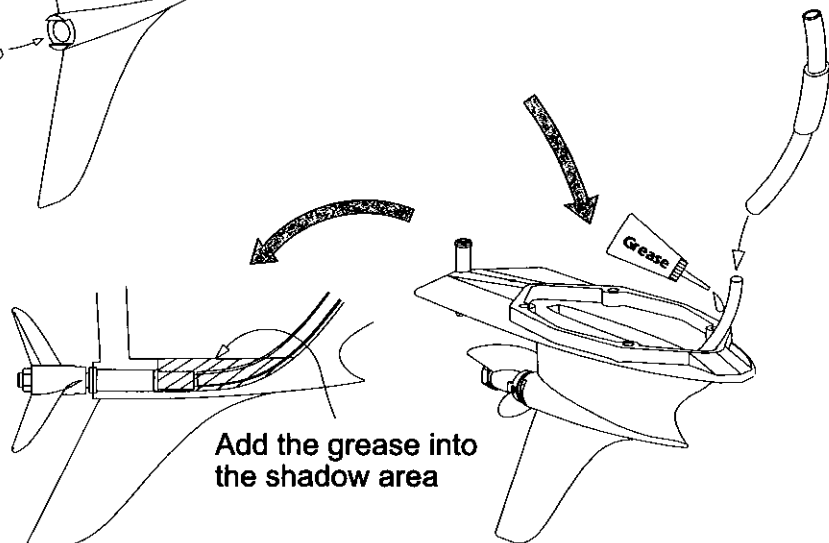

9 船外機 Out board unit

①  x4

2.6x16mm
Bind Screw

②  x4

2.6mm
Nut

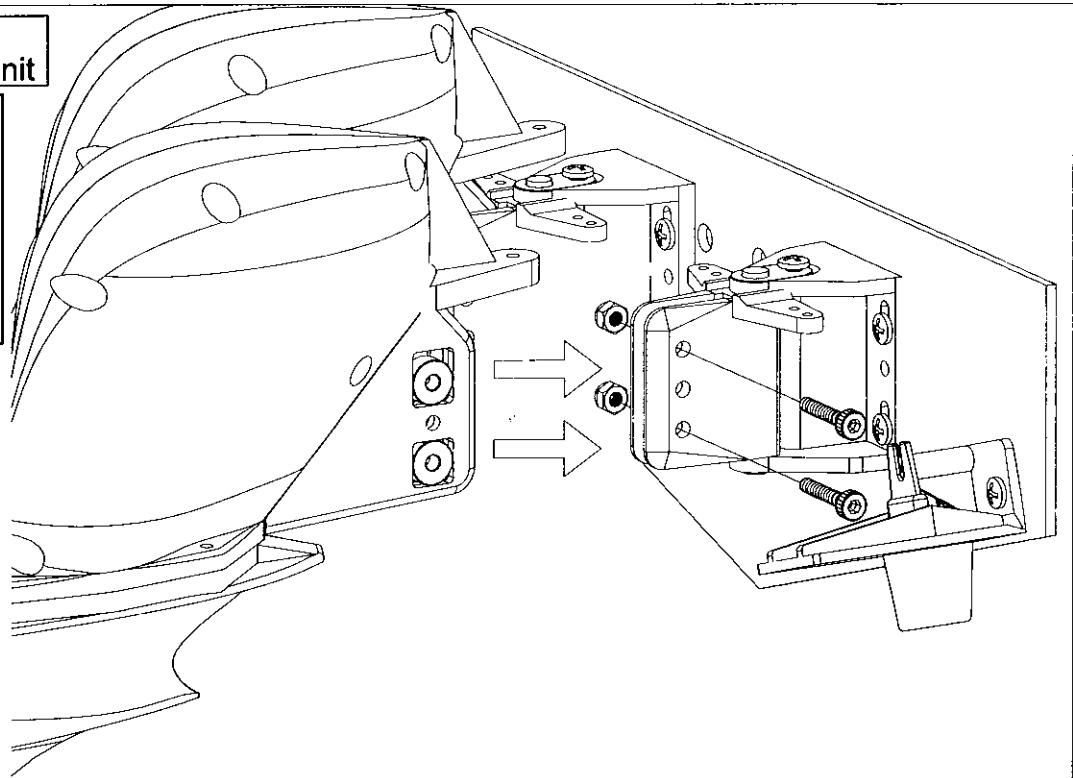

10 船外機 Out board unit

①  x4

3x10mm
Tapping Screw

②  x2

E-016

③  x2

A-030

④  x1

E-071

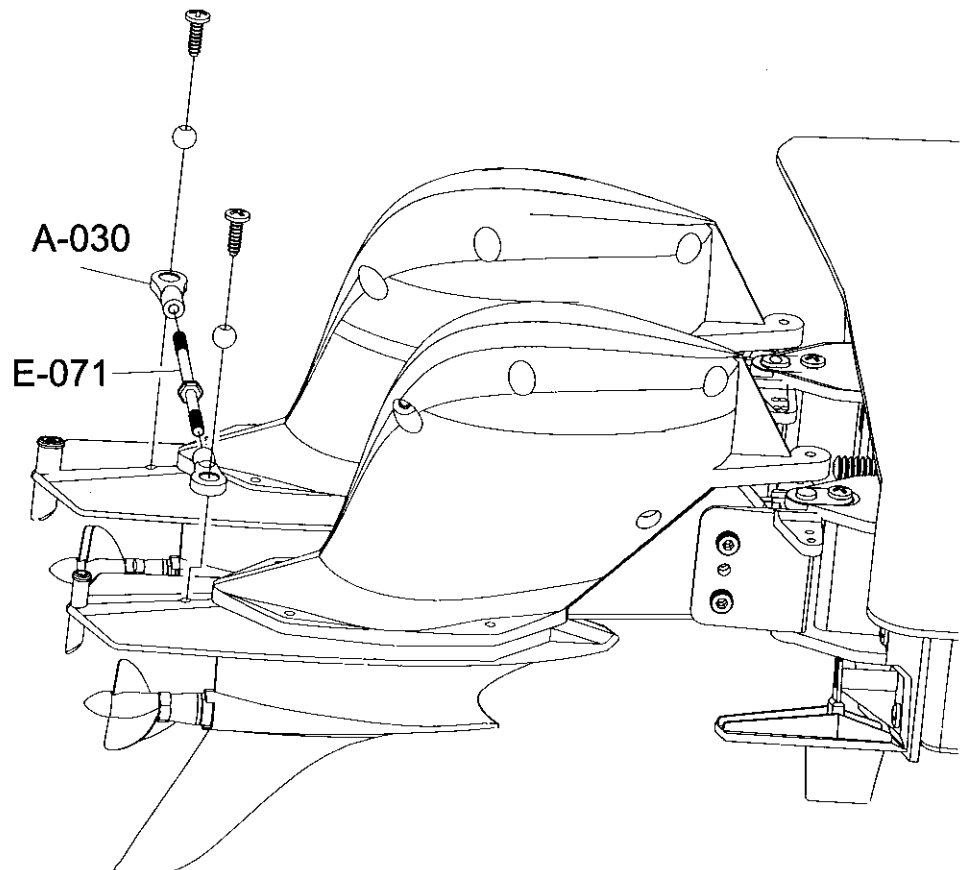

11 船外機
Out board unit

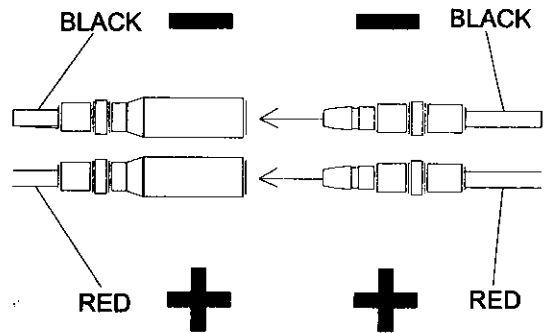
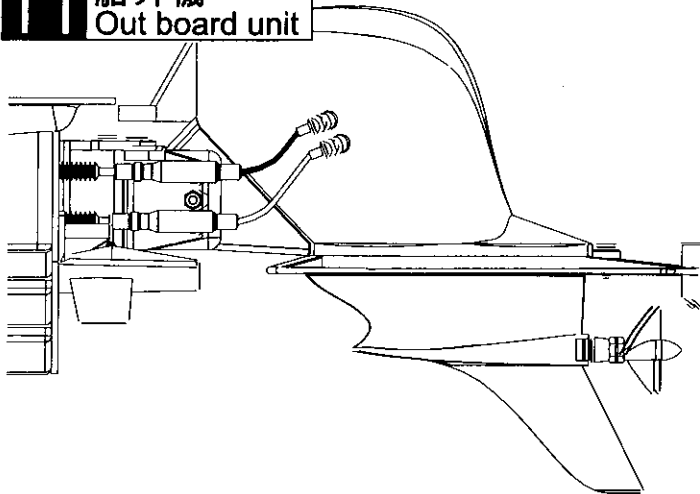

12 船外機
Out board unit

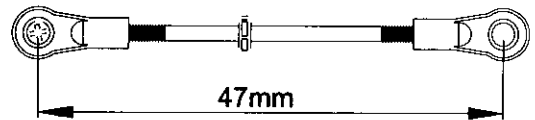
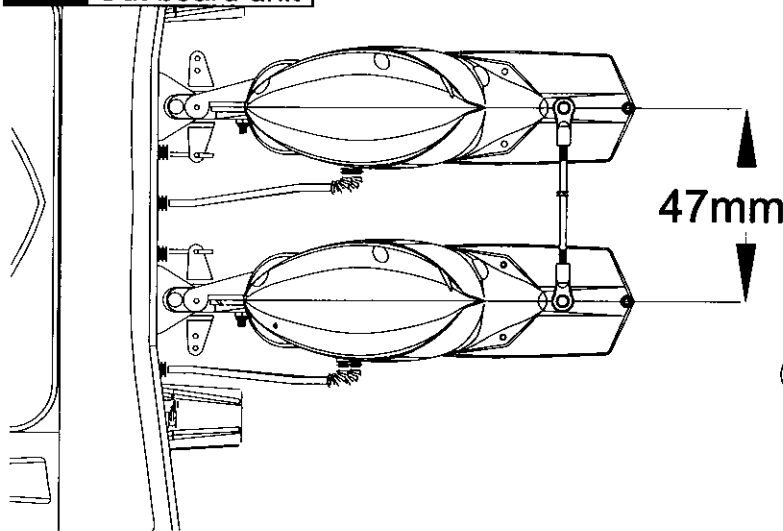

13 接收機
Radio throttle adjust

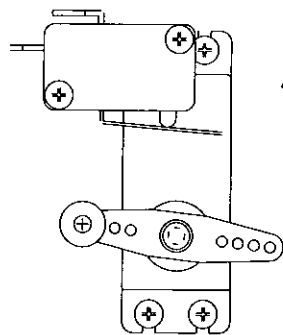

伺服机中立位置

Neutral
Neutral
Neutre
Neutro

送信機中立位置

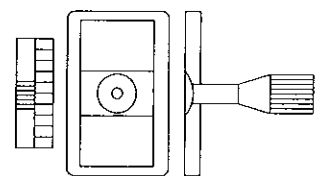

Middle speed

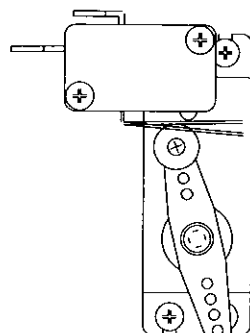

伺服机高速位置

Forward
Vonwärts
Avant
Hacia

送信機高速位置

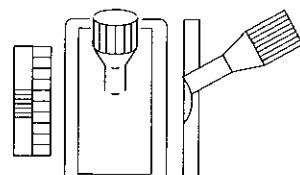

High Speed

14 Rudder Adjust

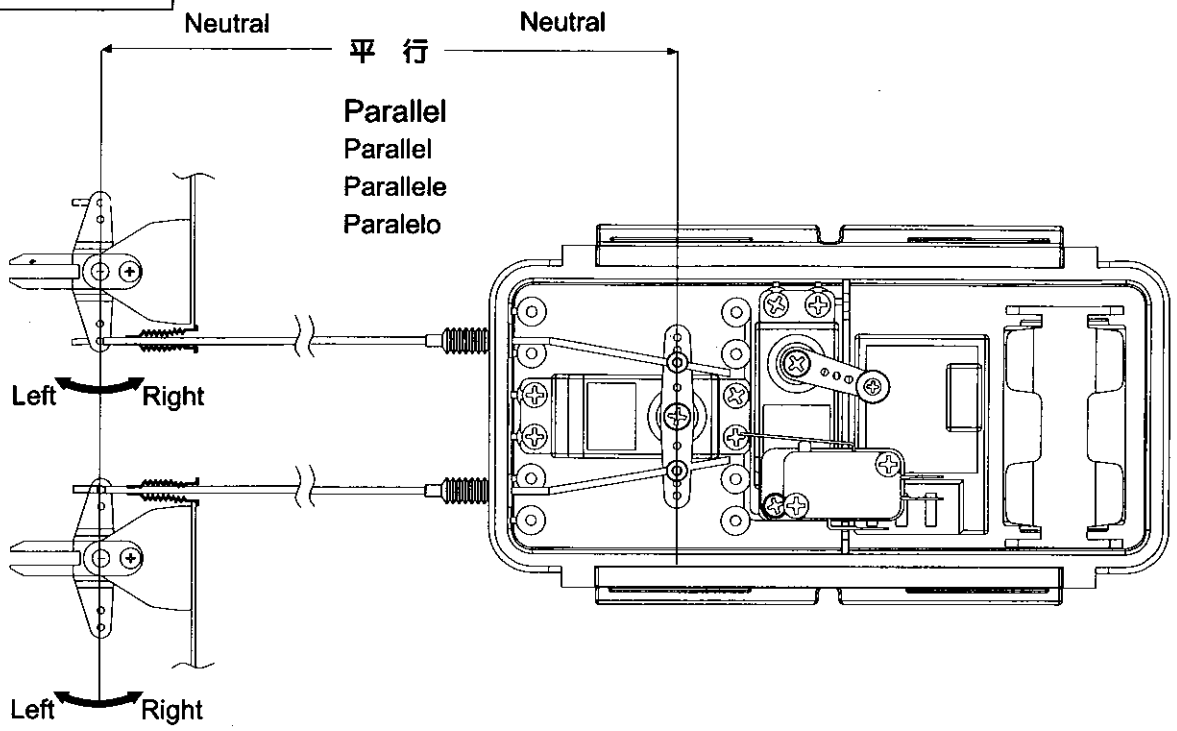

15 Apply Decals

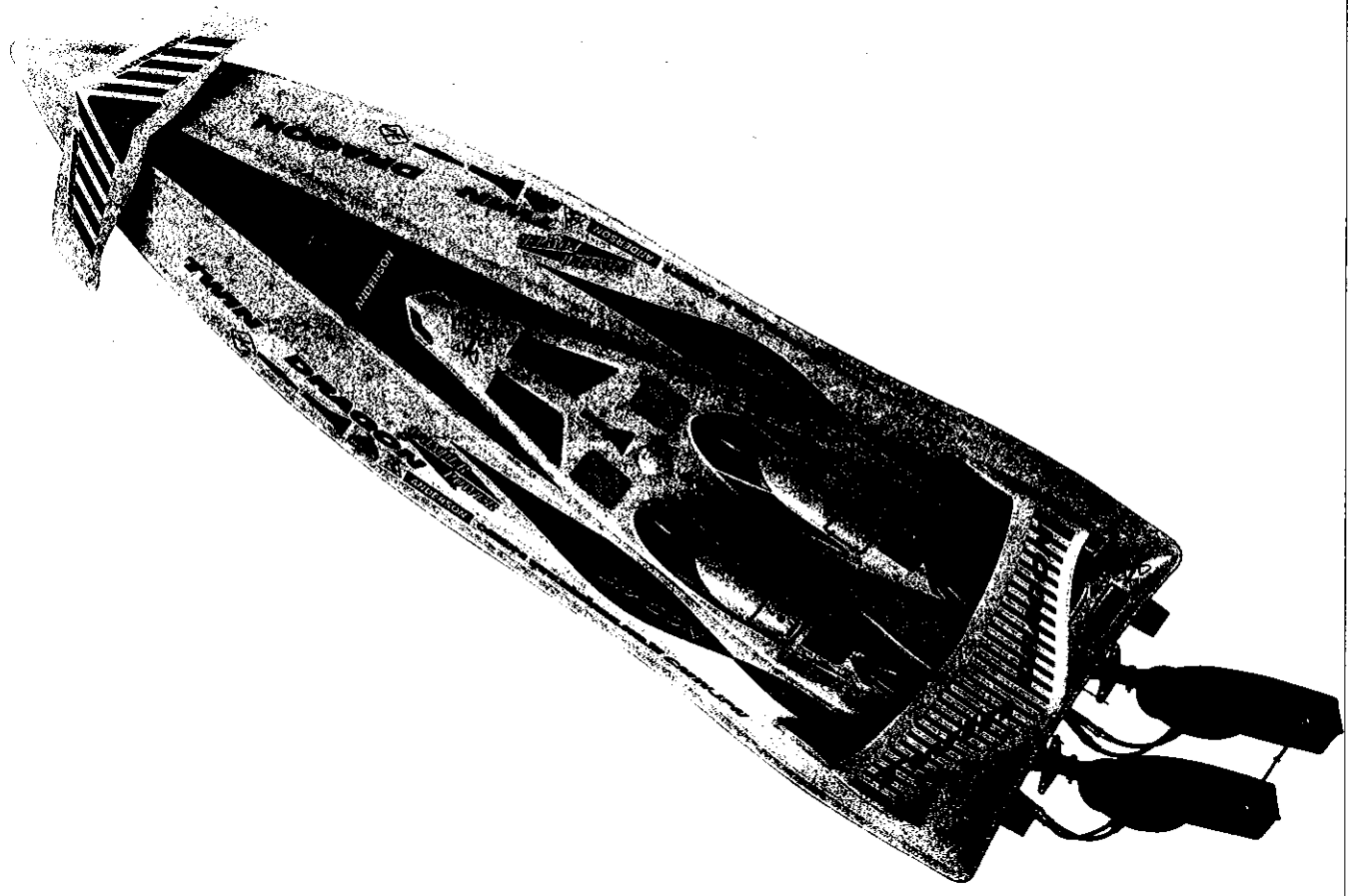

15 Apply Decals

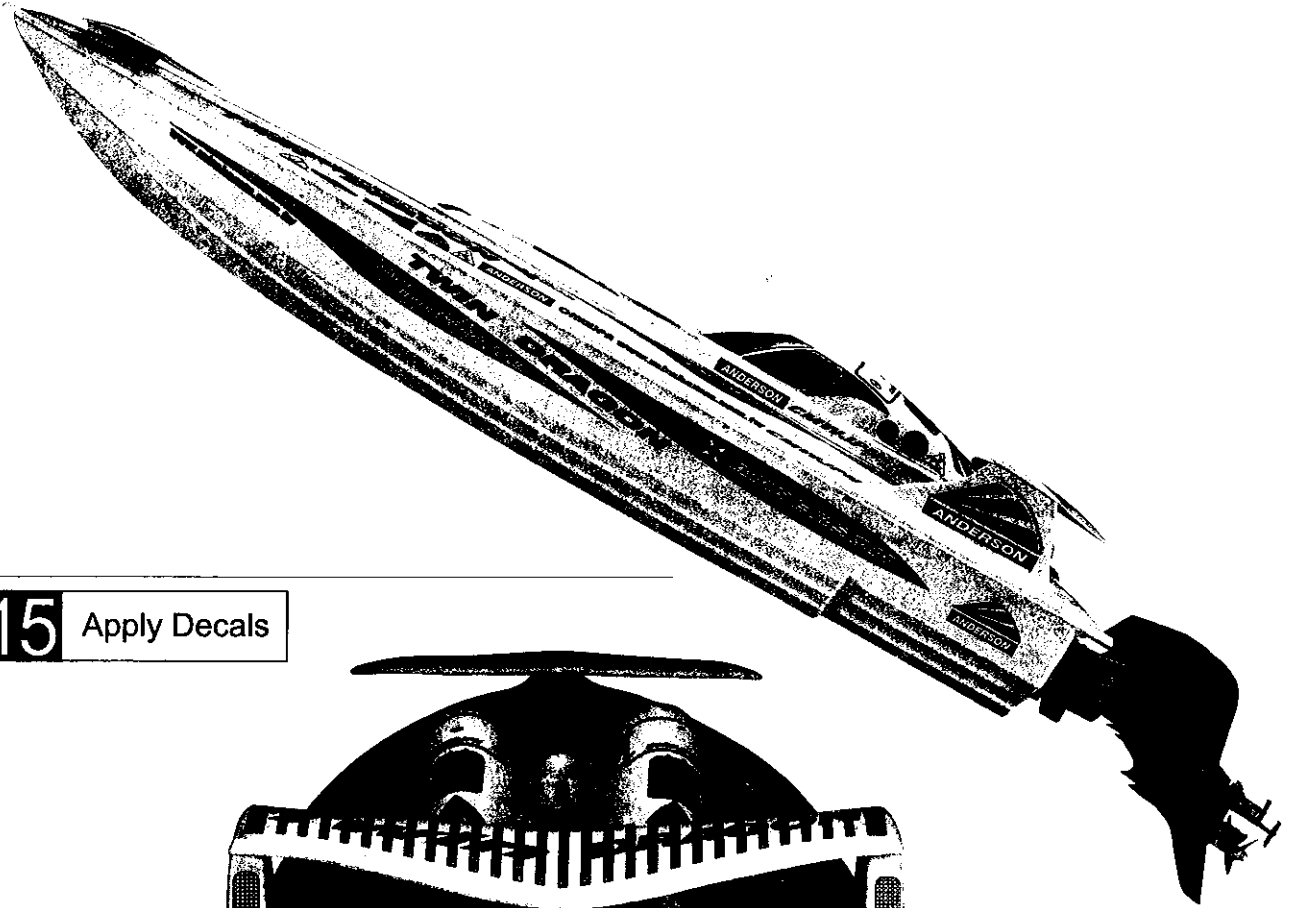

15 Apply Decals

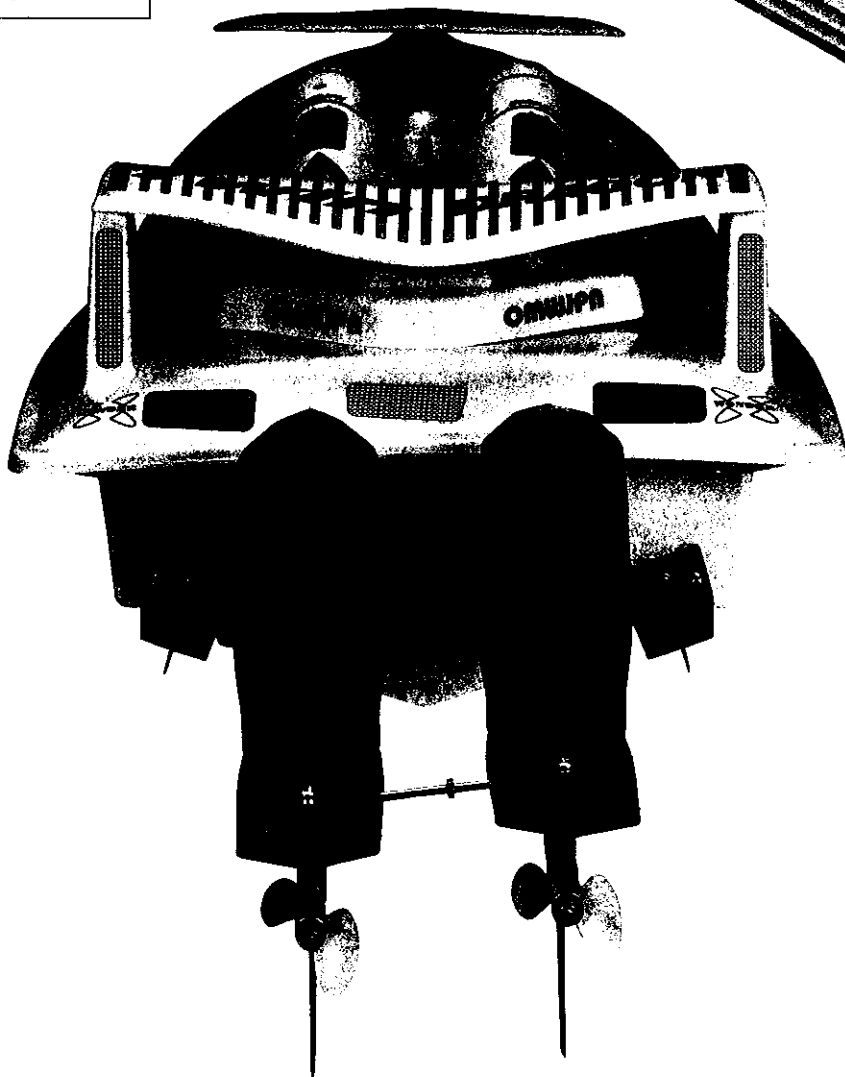

TWIN DRAGON PARTS LIST

Product Type Number **970009**

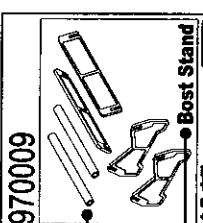
Product Sample 

Product Name **船架**

970009

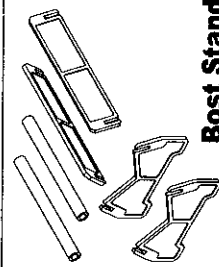

船架

Boat Stand

970011

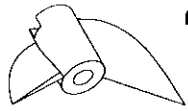

螺旋槳

Propeller

970012



56T齒輪

56T Gear

970014

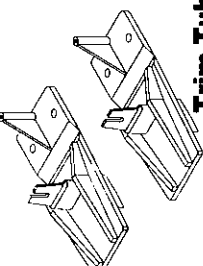

壓水板

Trim Tub

970017



44T齒輪

44T Gear

970022



防水套

Water Proof Boots

970031

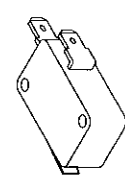

遙控開關

Speed Control Switch

970035



銅環

Bushing 4x8F / 4PCS

970027

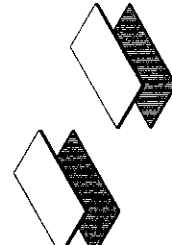

龍形帶

Magic Tape 25x40mm 6PCS

970027

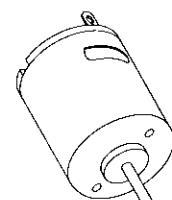

馬達

Motor

980015

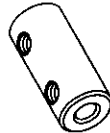

連接頭

Joint / 2PCS

990004

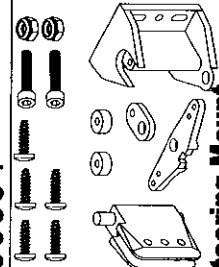

固定座

Steering Mount

990011

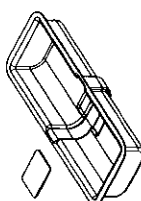

電池盒

Battery Holder

990006

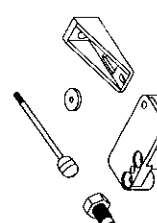

開關座

Switch Holder

990007

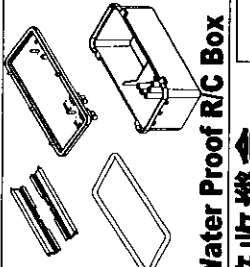

接收機盒

Water Proof RC Box

990008

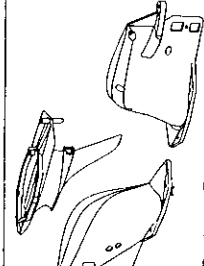

馬達上下蓋

Motor Cover

992001

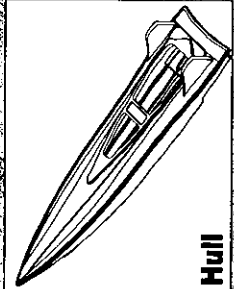

船體

Hull

992002

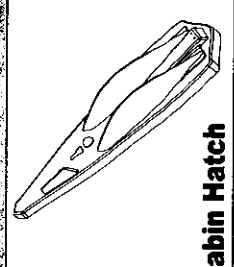

艙蓋

Cabin Hatch

992003

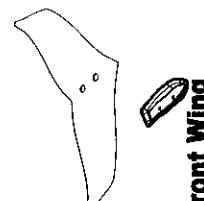

前定風翼-直型

Front Wing

992004

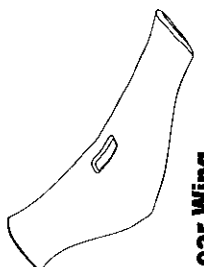

後定風翼

Rear Wing

990013

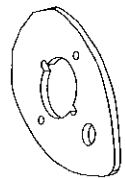

馬達座





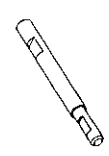





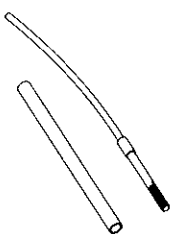

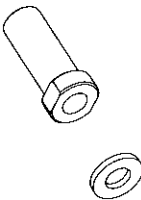
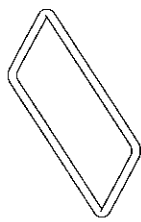
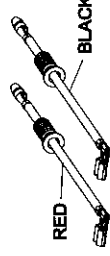

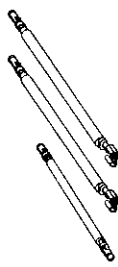
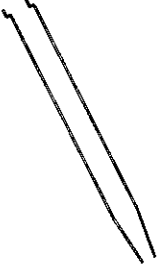
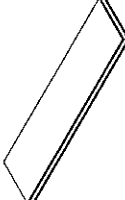
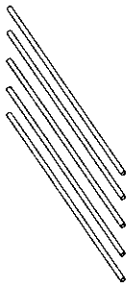

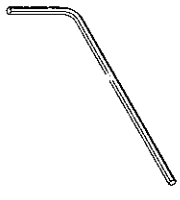
Motor Mount









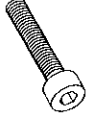
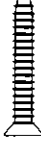

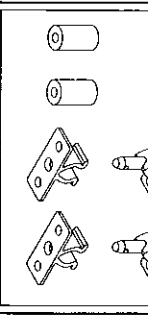

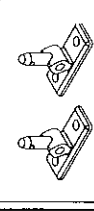
990014

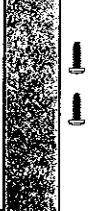

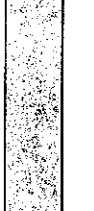
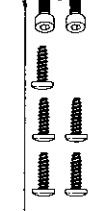
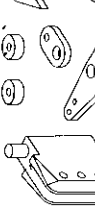
連接軸

Connect Shaft

990015	 Flexible Shaft 傳動軸	970025	 Prop Holder 螺旋槳固定座	990017	 Sleeve Shaft 1set 軸套	990018	 Seal Tube 防水條	992005	 Wire Set-M 馬達配線	992006	 Trim Tub 連接線
992007	 Wire Set-P	992008	 Rudder Rod	254070	 Double Sided Tape 2x20x150mm 2PCS	254071	 Antenna Tube 5PCS	254072	 Hex Wrench 1.5mm 6PCS	254075	 Hex Wrench 2mm 6PCS
254029	 Set Screw 3x3mm 6PCS 無頭內六角	254030	 Set Screw 4x4mm 6PCS 無頭內六角	254070	 Tapping Screw 3x10mm 6PCS 結合十字自攻	254071	 Tapping Screw 3x15mm 6PCS 結合十字自攻	254072	 Bind Screw 3x8mm 6PCS 結合十字自旋	254075	 Washer 2x5mm 6PCS 華司
254029	 Tapping Screw 2x8mm 6PCS 圓頭十字自攻	254030	 Nylon Nut 2mm 6PCS 尼龍螺帽	254070	 Nylon Nut 3mm 6PCS 尼龍螺帽	254071	 Nut 4mm 6PCS 螺帽	254072	 Hex Screw 3x15mm 6PCS 圓頭內六角自旋	254075	 Tapping Screw 3x20mm 6PCS 平頭十字自攻

<p>990031</p>  <p>O-ring SW Set</p>	<p>180280</p>  <p>Push Rod Connector EA-180280 2SET</p>	<p>99028</p>  <p>O-Ring 6PCS</p>	<p>99029</p>  <p>Decals 1PCS</p>	<p>992009</p>  <p>Steering Set</p>	<p>970013</p>  <p>Hatch Holder</p>
<p>990001</p>					
<p>990002</p>  <p>Outboard unit</p>	<p>990032</p>  <p>Sw Set With Hardware For RX Box</p>	<p>990032</p>  <p>1SET OB Drive Set</p>	<p>990032</p>  <p>1SET OB Driver Set W/Steering Mount</p>	<p>990032</p>  <p>Water-proof RX Box with SW Set For EP/GP Boat</p>	<p>990032</p>  <p>RX Box</p>
<p>990004</p>					
<p>992004</p>  <p>Back Plate</p>	<p>992004</p>  <p>Steering Mount</p>	<p>992004</p>  <p>Steering Mount</p>			